

Advice section Engineered wood flooring

PARADOR

Table of contents

Applications	Page 3
The right choice	Page 3
Engineered wood flooring and indoor climate conditions.....	Page 5
Product structure.....	Page 6
Technology.....	Page 7
Accessories	Page 8–10
Installation overview	Page 11
Installation rules	Page 12–14
Subfloor requirements	Page 15
Installation options	Page 16
Assembly engineered wood flooring with Automatic-Click® system	
› Basic 11-5; Classic 3025, 3060; Trendtime 3, 4, 6, 8; Edition Floor Fields.....	Page 17–19
Assembly engineered wood flooring with Allround-Click® system	
› Trendtime 3 (herringbone).....	Page 20–21
Assembly engineered wood flooring with tongue and groove connection	
› Edition New Classics	Page 22–23
Assembly engineered wood flooring with free and fixed tongue connection	
› Edition Open Frameworks	Page 24–26
Value retention, cleaning and care, including floors with lacquer surface extra matt professional	Page 27–28
Checklists	
› Template acceptance protocol	Page 29
› Underfloor heating system	Page 30–31
› Whole-area glue-down	Page 32

Allround-Click®, Automatic-Click®: Registered as a Union Trademark

You will find important information about installation on the pack leaflets or product packaging or in available product-specific instructions. For special applications, additional information is also available through Parador Application Technology.

Please also pay attention to the technical data sheets, declarations of performance, certificates, and installation videos, which you will find on the Parador website www.parador.eu.

The following standards are also relevant for the use of Parador engineered wood flooring:

DIN 18202	Tolerances in building construction
DIN 18299	General conditions for construction work of any kind
DIN 18365	Flooring work
BEB publication	Evaluation and preparation of subfloors; heated and unheated floor constructions

Applications

Application possibilities

With Parador engineered wood flooring, your ideas are quickly and easily turned into reality, as this high-quality engineered wood flooring can be installed in no time at all thanks to the patented Automatic-Click® and Allround-Click® systems and long-established tongue and groove connection. Parador engineered wood flooring combines naturalness individuality and durability. The large selection of exquisite wood types in various board sizes, surface finishes, aesthetical gradings and installation designs. Parador engineered wood flooring can be used in both residential and commercial buildings depending on use except wet rooms (please refer to our Chapter 'Installation rules' under the section heading 'Installation in wet rooms').

The right choice

Not all engineered wood flooring is the same: Prior to your purchase you should make sure that your chosen engineered wood flooring suits your needs. In addition to the wood type, visual requirements to grade of wood, the top layer thickness, the quality of the click connection, and surface finishing are of particular importance. Parador gives you a choice between oil impregnation, pure natural oil, and multi-layered lacquer finish. However, whether you choose a lacquered or oiled floor, a specific wood type or a particular colour – the choice almost certainly comes down to a matter of personal taste.

Oil impregnated (U.V. oil), natural oil and natural oil plus surface treatments for engineered timber flooring

Parador oil impregnation (U.V. oil) is a very effective surface treatment, which unlike other oil or oil and wax systems does not need any time-consuming care or treatment. Parador natural oil is based on natural raw materials made from plants. The factory treatment means that the oil penetrates the wood to allow the open-pored wood surface to retain its natural, resistant texture. Parador's natural oil 'plus' factory surface treatment does not require an additional maintenance oil application on completion of the flooring installation and is ready to walk on immediately unlike the natural oil factory surface treatment (only products in the Basic 11-5* product range) which requires an additional coat of Parador natural oil maintenance product. Regular maintenance is required for both natural oil and natural oil 'plus' depending on the amount of use that the floor will have to withstand to retain the aesthetics of the floor. Please refer to the information from the chapter Value retention, cleaning and care – Maintaining lacquered finishes and naturally oiled/naturally oiled plus/oil impregnated surfaces (UV oil), the product-specific instructions as well as the information from the associated technical data sheets (parador.de/en/services/downloads).

The benefit of a natural oil finish is basically that the treatment emphasises the natural look and character of the wood. Unlike with an oil impregnated finish, with naturally oiled and naturally oiled plus engineered wood flooring it is possible to renovate small areas, meaning that you can repair small damaged areas just where it is necessary. On the flip side, natural oiled floors are more susceptible to scratches and indentations compared to lacquered surfaces although they are easier to repair. Liquids spills such as coffee and red wine can also be as easily removed on a naturally oiled floor as on a lacquered floor. (Please refer to our cleaning and care instructions in the chapter headed Value retention, cleaning and care.)

* For products in the Basic 11-5 engineered wood flooring range, Parador recommends a maintenance oil application following flooring installation for long-term maintenance of the original look (please use the profile care oil from the Parador range).

The right choice

Lacquered engineered wood flooring

The Parador lacquer finish offers a very balanced protection of the wood with an elegant look at the same time. Optimum protection with suitability for everyday use is possible only if the lacquer is hard enough to ensure wear resistance, and resilient enough to avoid cracking under a high load. Parador lacquer finish is perfectly balanced and guarantees appropriate suitability for everyday use.

Wood grading

Wood grading encompasses specific inherent parts of a tree such as knots, sapwood, cracks, medullary rays etc., that ultimately reflects in the visual appearance of the wood. Parador's own grading guidelines result in 5 different grades, Select, Natur, Classic, Living and Rustikal. This results in a divergent visual appearance of Parador's timber floors (for further information, please refer to Parador's technical data sheets).

Hardness of the wood types

Hardness is the resistance that the wood uses to resist the impact of a solid body under load. The hardness essentially depends on the type of wood. The Brinell method is the most common method for determining hardness. Brinell hardness HB is measured in N/mm² at a wood moisture level of 12%. The higher the value, the harder the wood.

Wood type	Density g/cm ³	Brinell hardness N/mm ²	Hardness class
Maple	0.72	48	4
Beech	0.68	34	3
Oak	0.71	34	3
Ash	0.72	39	4
Cherry	0.58	30	2
Larch (also smoked)	0.60	19	2
Californian walnut	0.64	26	2
Thermo oak	0.60	31	3
Walnut	0.60	31	3

The hardness of wood fluctuates based on the individual growing conditions. Values are therefore only approximate values.

Class 1: very soft wood · Class 2: soft wood · Class 3: hard wood · Class 4: very hard wood

Changes of shades from incidence of light

Daylight causes chemical reactions in the wood, which cause the shade of the wood to change. The shade changes only on the surface of the wood. Most wood types get darker over time, although dark wood tend to brighten and light-coloured wood tend to become yellow. The colour change causes the overall look of the flooring to become more even and balanced. Minor colour differences are automatically equalised over time.

Engineered wood flooring and indoor climate conditions

Wood is a hygroscopic material, which means that it can absorb and release moisture. On the one hand, this can have a regulating effect, but it can also be a disadvantage because wood swells when it absorbs moisture (gets bigger) or shrinks when it releases moisture (gets smaller). Whether it swells or shrinks depends directly on the room climate. If the climate is too warm and too dry, the wood shrinks; if it's too moist, the wood swells.

Multi-layer engineered wood flooring also shrinks and swells, but significantly less so than solid engineered wood flooring. Particularly in the winter months, when room humidity is often much too low (see illustration), the natural shrinkage of the material can lead to the creation of gaps. Conversely, when it is too damp, if the gap to the wall is not adequate or expansion joints are missing, the floor area may start to bulge upwards.

Note: Beech shrinks significantly more than most other commonly used types of wood. That is why more severe gaps may occur in the Beech engineered wood flooring in the winter when the room climate is too dry.

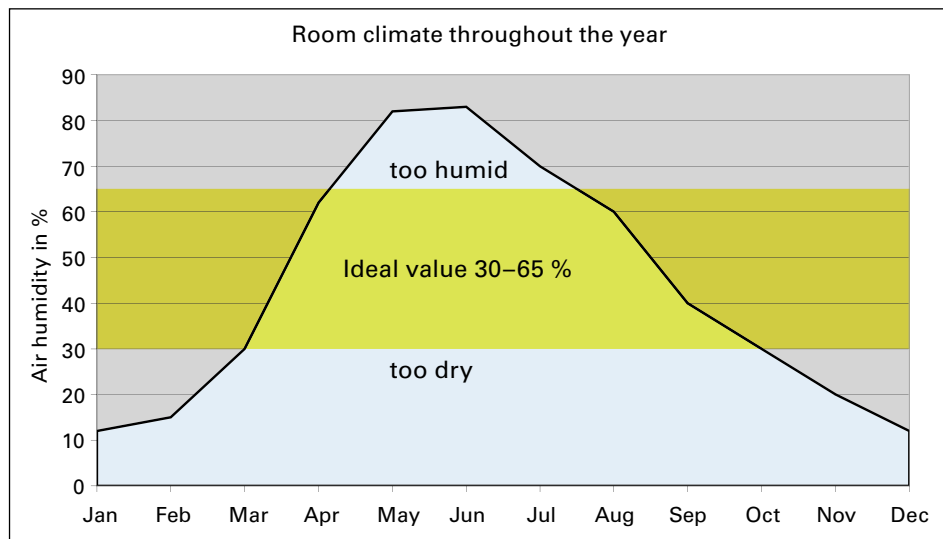

Product structure



①

Top layer

High-quality solid wood with a thickness of up to 4 mm is finished with a lacquered or naturally oiled surface. The lamella impregnation on the head side as well as the all-round impregnated top layer prevent moisture from penetrating and ensure enhanced swell-protection. The gentle drying process prevents cracking.

②

Softwood middle layer

The excellent dimensional stability of Parador engineered wood flooring even under maximum load comes from the solid wood core with its vertical annual rings. The patented click mechanism milled into the wood ensures a long-term stable connection.

③

Balancing layer paper

Manufactured in a resource-friendly peeling process, the balancing layer paper made of solid spruce also supports the plank's dimensional stability.

④

Click connection

The patented Parador click connections guarantee easy, fast, and simple installation with maximum pull-out resistance and a long-term stable connection to create permanently beautiful flooring and a solid bond between individual planks. Floating installation and whole-area gluing is easily possible because the planks are self-orienting. The floor is ready to walk on as soon as it has been installed.

Tongue and groove connection

Tried and tested installation type with a classic connection for maximum installation options.

Technology



Swell-protection

Parador engineered wood flooring



Automatik-Click® system

Basic 11-5
Classic 3025, 3060
Trendtime 3, 4, 6, 8



Allround-Click® system

Trendtime 3 (herringbone)



Tongue and groove connection

Edition New Classics
Edition Open Frameworks (with loose tongue on the end edge)

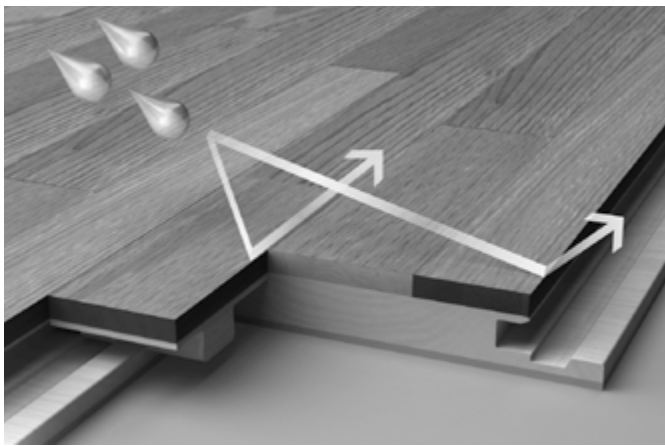

Excellent swell protection

The lamella impregnation as well as the all-round impregnated top layer ensure enhanced swell-protection. Each individual strip is also impregnated on the edges. For reliable protection against moisture, swelling, and soiling.

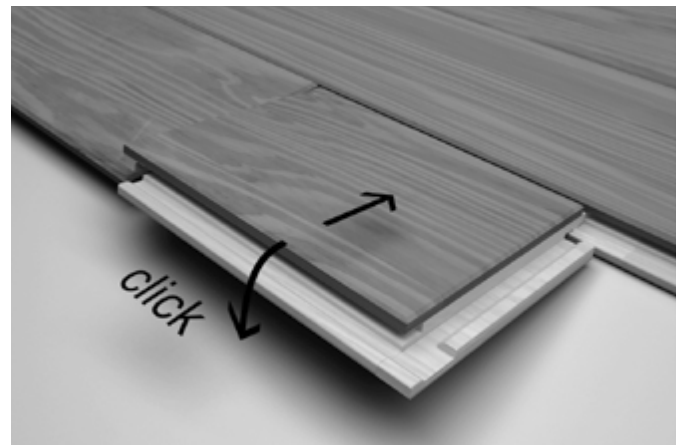

Patented click mechanism

Installation is quick and easy without glue thanks to the patented Automatic-Click® system with long and end edge locking mechanism.

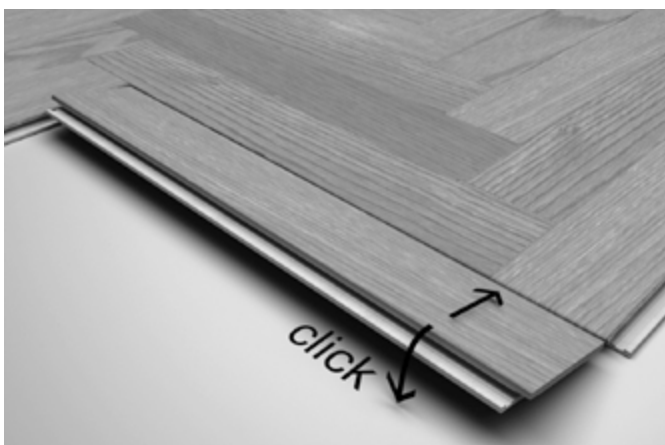

Innovative installation system with Trendtime 3 herringbone

The innovative Allround-Click® system without left or right strips for easy installation.

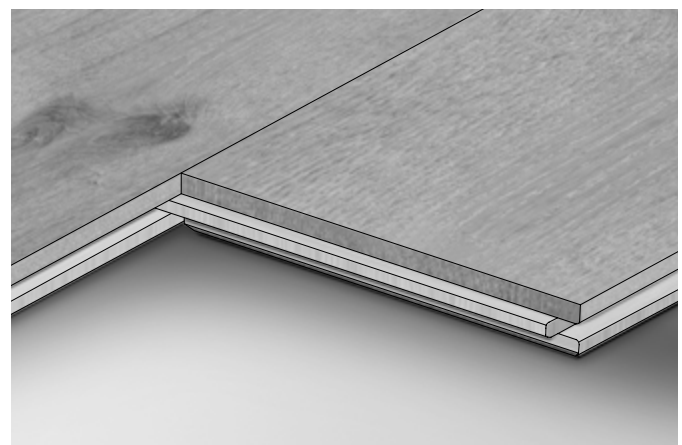

Classic tongue and groove connection/no-groove tongue connection

The all-round tongue and groove profile is characterized by maximum fitting accuracy and ease of installation. The use of a loose tongue in Open Frameworks offers countless installation options.

Accessories

Underlays

A suitable underlay must always be used between the substrate and the floating engineered wood flooring. Underlays reduce ambient noise and footfall sound, compensate for minor bumps and – depending on the finish – can provide the necessary moisture protection for mineral substrates. For all existing substrates, which consist e.g. of dry floorboards or chipboard, only footfall sound insulation is used. A vapour barrier must not be used in these cases, otherwise mould may form in the underlay. A moisture barrier is mandatory with all mineral substrates (screed, concrete, tile), as otherwise moisture from the substrate may penetrate the flooring, which in turn may cause cupping or warping.

An ambient noise and footfall sound protection or a combination product must also be used.

Comprehensive information about underlays can be found in our catalogues and online under www.parador.de/en.

Parador offers the right underlays for every application.

Akustik-Protect 50

- › integrated vapour barrier

Akustik-Protect 80

- › without integrated moisture protection, e.g. for installation on wooden substrates

Akustik-Protect 100

- › integrated vapour barrier
- › good footfall sound and ambient noise insulation*
- › no additional moisture protection required (PE film)

Akustik-Protect 500

- › integrated vapour barrier
- › even better characteristics than Akustik-Protect 50, 80 and 100
- › no additional moisture protection required (PE film)

PE film

When installing on mineral substrates without the use of underlays with moisture protection, additional moisture protection (PE film) is absolutely necessary.

Aluminium adhesive tape

- › for sealing the butt joints between the underlays for improved moisture protection

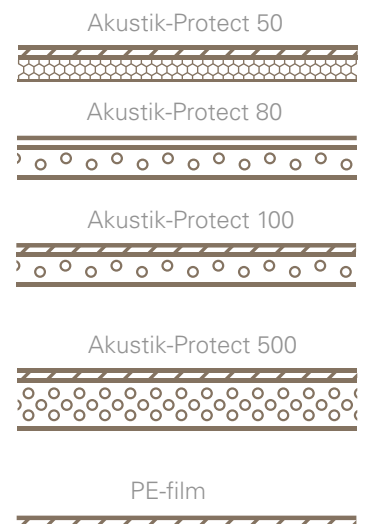

* Footfall sound is directed downwards, in other words is perceived in the rooms on the floor below; Ambient noise is directed upwards and is perceived in the room where it occurs.

Accessories

Skirting boards

For a perfect finish, the Parador product range includes the right decor skirting board to match every floor design. It is attached to the wall using the Parador construction adhesive or the special plastic clips with integrated cable conduit. Caps and corners complete the product range.

Skirting board assembly instructions

The flooring is ready to walk on immediately after floating installation or after hardening of the glue for Edition. Remove the Parador plastic spacer wedges and attach the Parador skirting board using the patented clip technology or Parador assembly adhesive.

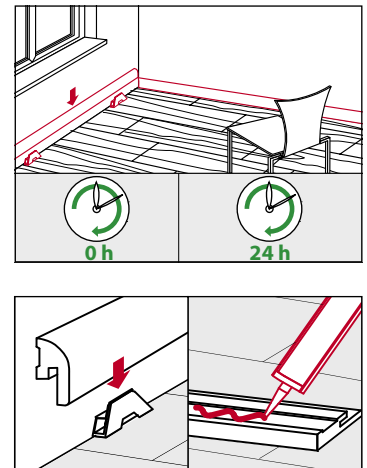

Aluminium profiles

Parador aluminium profiles combine, bridge and adjust and are suitable for stair edges. The basic profiles are screwed into the subfloor or – in particular with an underfloor heating system – are glued to the subfloor. Insert cover profiles or screw down aluminium profiles – done.

Aluminium profiles are suited for use with floor coverings with a thickness of 8 to up to 18 mm.

Note: Please refer to the application description on the product label.

Transition profile

Cover dimensions: 36 mm

The integrated slope adjustment enables a transition from floor coverings (carpet, tile, etc.) with a thickness of 5 to 20 mm.

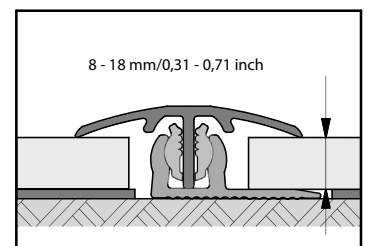

Adapting profile

Cover dimensions: 45 mm

The integrated slope adjustment enables a transition from screed and/or floor coverings (carpet, tile, etc.) with a thickness of 0 to 20 mm.

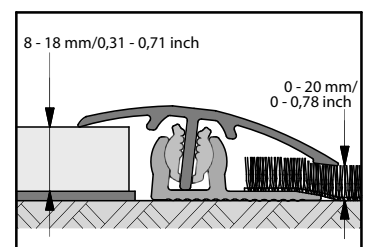

Accessories

End profile

Cover dimensions: 26 mm

Note: For floor coverings with a thickness of 8 to 18 mm.

Stair edge profile

Cover dimensions: 28 mm and 23 mm to the step

Note: For floor coverings with a thickness of 8 to 18 mm.

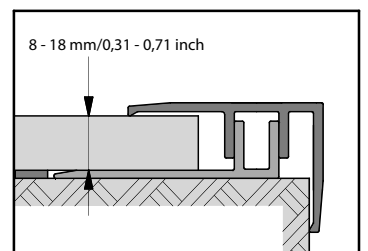
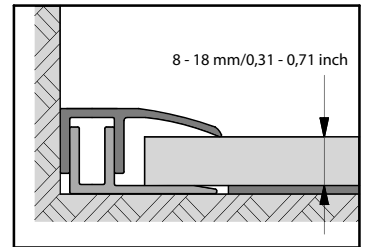

Tool

You will need the following Parador tools and aids for installing Parador engineered wood flooring:

Tape measure or hinged ruler, cutter knife, pencil, handsaw, Parador plastic spacer wedges, Parador MultiTool, hammer, drill and jigsaw, crosscut saw, or circular saw, and possibly glue for whole-area gluing.

Other tools and materials may be required, depending on the application: "Gun" for construction adhesive, metal saw for aluminium profiles; Parador glue D3.

Note: For a perfect result of your installed floor down to the last detail, you will need covers, e.g. to cover movement joints around radiator pipes routed through the floor which can be sourced from various specialist outlets.

Installation at a glance

Engineered wood flooring can be installed in two ways: whole-area gluing or floating installation. Whole-area glued engineered wood flooring is comparably quiet because vibrations and hollow spaces are chiefly excluded. The floating installation of Parador engineered wood flooring is fast and easy even without prior knowledge thanks to the simple Automatic-Click® system – that's why it's the most popular installation method.



Lay out the underlay on the prepared substrate.



Centre/angle the installation area and adjust the first row of planks by cutting it to size.



Use the plastic spacers to maintain a clearance of at least 10 to 15 mm from all walls and fixed objects in the room..



Cut the last plank of the first row to the necessary length, considering the wall clearance. The cut piece of the plank is used to start the second row.



Start the next row from the left. Simply click the long sides of the planks together. The planks must not be glued.



Join head joints using a hammer and protective block. The long and head joints will connect automatically. Continue this installation throughout the whole room.

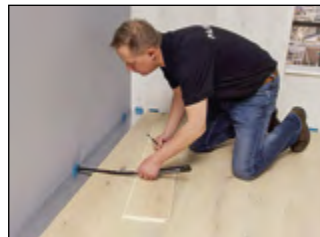

Use a remnant or the Parador MultiTool to transfer the wall outline to the last row of planks.



Cover edge clearances using matching skirting boards from the extensive Parador product range.

Detailed installation information is available starting on page 16.

The installation of engineered wood flooring Trendtime 3 (herringbone) and engineered wood flooring Edition New Classics as well as Edition Open Frameworks deviate from this. Detailed installation instructions can be found from page 21 onwards. Separate instructions for installing Trendtime 8 Beech and Trendtime 8 Oak Multiplank engineered wood flooring can be found on page 17. Before installation, please observe the installation rules listed on the following pages. Compliance with these instructions is a requirement for successful installation and helps guarantee that you can enjoy your new engineered wood flooring for a long time.

Installation rules

These installation rules and the assembly process shown below are generally applicable. Additional special or different rules or notes may be listed in the pack leaflet of the relevant products. These must be complied with as they are binding.

Installation video – Installing Parador engineered wood flooring correctly (incl. surface treatment oils)

Note:
Click into the text "Video installation", QR code, or scan the QR code



1. Inspecting for material damages

Engineered wood flooring planks should be checked thoroughly for material defects before and during installation (e.g. improper transportation) (Figure 1). Planks with visible defects or damage must not be installed. Assembly should only take place in daylight or with adequate lighting, as any damaged or faulty boards may not be detected.

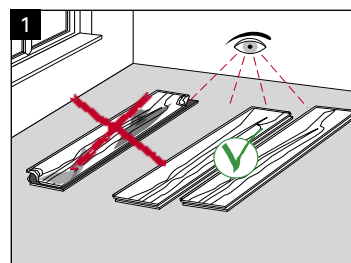

2. Acclimatisation before installation

Engineered wood flooring planks must be acclimatised over a period of at least 48 hours at a room temperature of at least 17°C and a relative humidity of 30–65% in the room where they are being installed (Figure 2). That means that the sealed packages must adjust to the climate conditions in the room. If there are major climate differences between the storage area and the room of installation, the acclimatisation period should preferably be longer. If the climate conditions are almost the same, the period can also be shorter.

Please store the packages on an even base without opening them. It is essential that you comply with these points, especially in new builds where the humidity is usually very high.

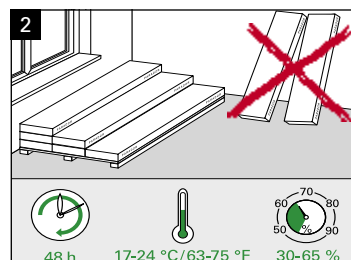

3. Installation in damp rooms

No installation in permanently damp rooms/wet rooms

Engineered wood flooring must not be installed in areas where water is likely to lodge on the floor (Figure 3). Standing water penetrates the wood and causes permanent damage.

In permanently damp areas or damp environments (sauna areas, small bathrooms etc.), engineered wood flooring should not be installed, as the risk of moisture penetrating cannot be ruled out. If engineered wood flooring is expected to be installed in larger bathrooms (recommendation: engineered wood flooring with natural oil or natural oil plus surface and whole-area gluing), care must be taken that it is not installed in close proximity to areas where water might lodge (shower, bathtub, toilet, sink) and that the relative humidity of the room is kept within the recommended range of 30–65%. The formation of puddles and the effects of damp must be prevented at the edges and in the joint areas – including expansion joints (Figure 4). Water penetrating underneath the flooring may also cause the formation of mould.

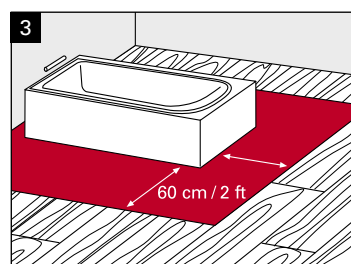

4. Subfloor condition

All existing subfloors must be level (max. 3 mm over 1 m length), dry, and sufficiently solid. In case of bigger uneven patches, these must be filled with commercially available filler. The subfloor surface should be without cracks, breaks, or gaps. Loose subfloors (PVC/carpet) must be removed. Mineral subfloors/screed must be sufficiently dry. In this regard please also note the information in the chapter "Subfloors":

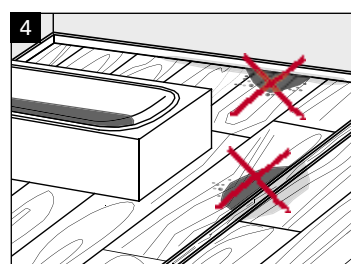

Installation rules

5. Vapour barrier for mineral subfloors

With dry, mineral subfloors, as a precautionary measure a 0.2 mm thick PE film or alternatively a Parador underlay with integrated moisture protection must be placed underneath. However, the PE film is only a vapour barrier and should be overlapped by approximately 30 cm and glued. Under no circumstances should a PE film be used to waterproof a building!

See also the chapter Underlays.

6. Maintain expansion joints/wall clearance

As already described above, the natural material wood swells or shrinks depending on climatic conditions. Therefore, installed engineered wood flooring requires a corresponding clearance to all fixed components, i.e. walls, supports, heater pipes, etc. This is called the wall clearance or expansion joint. Expansion joints are also required if a defined installation area is exceeded (see Installation Rule 7). Insufficient wall clearance is the most common installation error. This is frequently noticed in Summer, when increased air humidity and temperatures expand the engineered wood floor during the summer months.

The expansion joint or wall clearance should be at least 10-15 mm on each side, more on larger areas.

The general rule is:

Per meter of flooring at least 2 mm expansion joint on both sides of the room.
(Example: room width 5 m = min. 10 mm edge joint on each side).

Even if the installed material only abuts a single point in the room, the floating material may start to push up and warp. "Popular" weak points in this case are door frames, joints to stairs, radiators and end rails.

Heavy objects exceeding 350 kg placed on top of the flooring means that the flooring can move on one side only which therefore requires that the wall clearance on the opposite wall is left twice as large. Parador recommends that heavy objects or fitted furniture (such as kitchens, fitted units, aquariums etc.) are sited or assembled before the installation of the flooring (in the case of fitted units, the flooring can be installed just underneath the base). This will also allow the flooring to be removed if necessary. Expansion gaps at the wall area can be covered with skirting boards and in other areas with special flooring profiles. A permanent sealant may be used in areas with steel frames.

Note: Gaps in the screed, so-called furrows, must not be included if the gap is glued (e.g. with epoxy resin). It may be recommended to include heavy objects in planning the installation of a floating engineered wood floor (tip: joint gaps can be avoided if end edges in the load area are glued).

7. Layout of expansion joints

As engineered wood flooring will swell or shrink depending on climate conditions, further expansion and movement joints of at least 10 mm are necessary under the following circumstances:

- › larger areas (over 8 × 12 m)
- › irregular shaped areas
- › installation from room to room

These expansion joints are covered with corresponding transition profiles.

Note: The installer is always liable if expansion or movement joints are omitted.

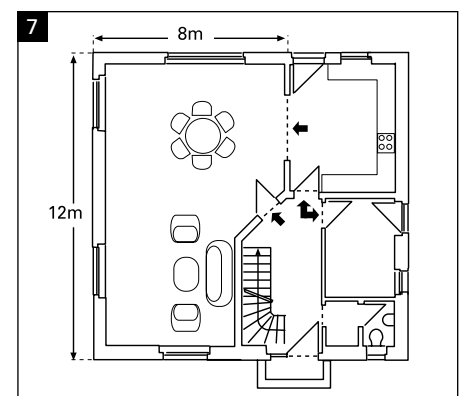
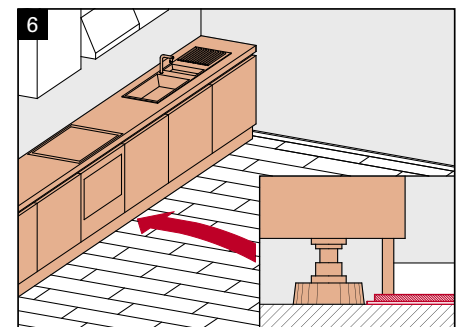

Installation rules

8. Pattern and offset installation

Engineered wood flooring planks can be installed in a symmetric or asymmetric pattern. In both cases the overlap or minimum offset of the head joints must be > 40 cm.

9. Installation direction/incidence of light

For optical reasons, the planks should be laid parallel from the incidence of light, i.e. the long side runs in the same direction as the light entering the room. If there is more than one window, please go by the largest window. If the floor plan of the room is very unusual, the direction of installation should also be judged according to how the room is divided (see Installation Rule 10).

10. Installation direction/room floor plan

Also for optical reasons, the long sides of the floor should be at right angles to the long side of the room. This makes the room appear squarer and bigger instead of long and "tube-like".

Note: Installation should take place from the brighter areas of the room to the darker ones (e.g. from the window towards the room).

11. Installation from multiple packages

Engineered wood flooring is a natural product that enhances its unique character with colour and texture. These natural features are always different. Therefore, it is always necessary that planks from different packages are mixed during installation in order to maintain a balanced appearance.

Note: There is one exception with Trendtime 8 Oak Multiplank: Here, the planks are already mixed at the factory and should be installed carton by carton/always from one carton only. During installation, care should be taken to maintain the mix of differently designed planks.

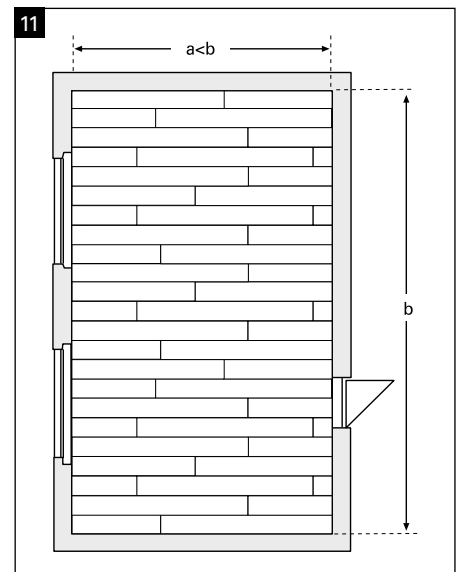
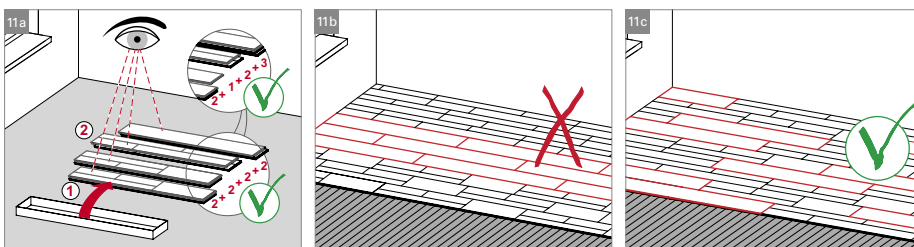
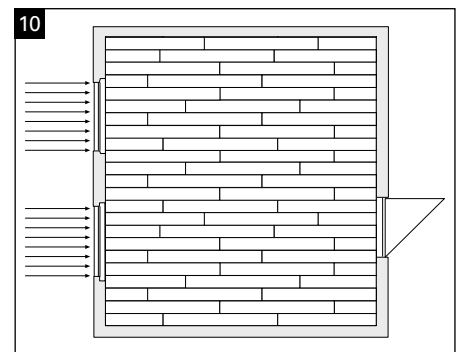
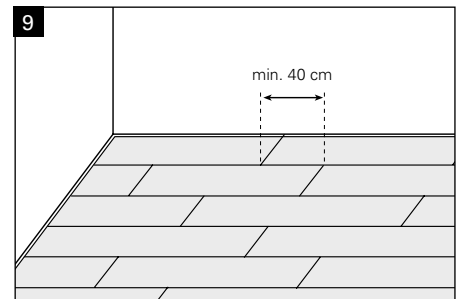
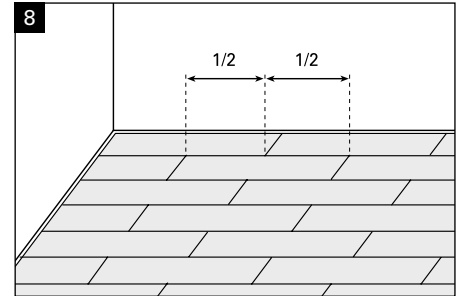

Subfloor requirements

- › The basic requirement for laying engineered wood flooring is a firm, clean, dry and even subfloor.
- › Uneven areas of more than 3 mm across 1 m must be evened out with a suitable filler (Figure 1).
- › When installing over old wood planks and particle boards, any loose planks/boards must be screwed to the substructure to reduce any creaking. The floor should be laid at right angles to the lengthways direction of the wood planks/boards underneath.
- › For reasons of strength and from a hygienic point of view, carpets are not suitable as a subfloor and must be removed (Figure 2).
- › We only recommend an installation on older PVC, CV or linoleum coverings if the flooring is glued in place, has no loose areas and there is no underfloor heating.
- › Screeds must not exceed the following moisture level:

	Anhydrite screed	Cement screed
without underfloor heating system	max. 0.5 CM %	max. 2.0 CM %
with underfloor heating system	max. 0.3 CM %	max. 1.8 CM %

Generally speaking, the screed moisture must be tested using a suitable test measuring device. A test sample must be taken from the bottom third of the screed composition, whereby the thickness of the screed must be measured and documented at each test point. The figures only apply to screeds without additives. For screeds with additives, or quick-drying screeds, the figures specified by the manufacturer should be observed.

With mineral subfloors*, as a precautionary measure a 0.2 mm thick PE film must be placed underneath as a moisture barrier (allow strips to overlap by at least 30 cm, apply adhesive tape, allow to protrude at the edges to form a trough and cut off the excess with a knife after attaching the skirting board). Or you can use Parador underlays with footfall sound insulation and integrated moisture protection. If moisture keeps on rising from the subfloor you must seal the surface with a suitable liquid sealant. Under no circumstances should a moisture barrier be used over wooden sub-floors. (Figure 3).

* Mineral subfloors include concrete, screed, stone.

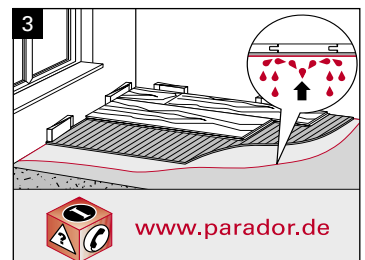
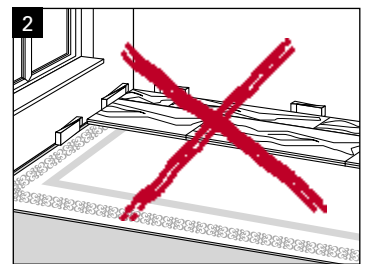
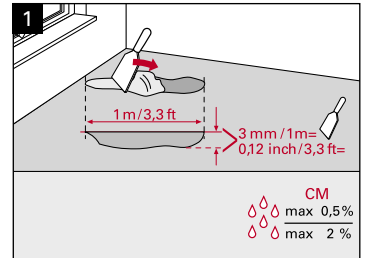

Installation options

1. Floating installation

If the engineered wood flooring is installed without a fixed connection with the subfloor, i.e. only the planks are joined to one another, we call that "floating installation". The flooring can move or float freely on the underlay. Thanks to the simple click technology, Parador engineered wood flooring can be installed in this way with ease and without prior knowledge.

2. Whole-area gluing

Whole-area gluing is another installation type. Here, the complete engineered wood flooring is glued on the screed using special adhesives. This installation is permanent, i.e. removal is very time consuming. However, one advantage of this option is that noise is reduced significantly, meaning that the floor is quieter to walk on. Installation on glue is easy when using products with Automatic-Click® or Allround-Click® system. The planks must not be moved in the glue, as is the case with other click connections. This guarantees an easier, cleaner, and faster installation than with common engineered wood flooring. Please also note the attached "Checklist for whole-area gluing of Parador engineered wood flooring".

Please always glue the following engineered wood floors over the whole area: Trendtime 3 Herringbone, Trendtime 8 Beech elephant skin.

3. Installation on underfloor heating

Parador engineered wood flooring is suitable to be installed floating or glued all-over on hot water underfloor heating systems. The favourable heat transmission resistance allows underfloor heating to be run economically. Further information about the heat transmission resistances of our engineered wood flooring can be found in our technical data sheets. When it comes to installation/application, please also bear in mind the "Checklist for installation on hot water underfloor heating" in the appendix. The maximum surface temperature of 29°C must not be exceeded and a very fast heating process must be avoided. The Parador underlay Akustik-Protect 80, 100 or 500 should always be used as the underlay for floating installations.

Note: The wood types beech and maple react sensitively to moisture and temperature fluctuations. The formation of gaps can therefore not be ruled out.

Please note the following for installation on electronic underfloor heating systems:

- › installation only with systems that have temperature sensors and controllers
- › no installation on older design electric underfloor heating systems (installed before 2000)
- › no installation on night storage heaters

4. Use of floor cooling

According to prevalent expert opinions, cooling a room by maximum 5 °C is easily possible at a maximum relative humidity of 65 % (according to the workplace directive, the lower floor temperature limit of 19 °C should also be maintained in "normal" residential housing. People are more prone to ill health in areas with cold floors). Parador floor coverings can be used without restrictions if these specified conditions are complied with (whilst bearing in mind the main Parador installation and fitting instructions). When installing on underfloor heating or cooling systems, it is essential to check with the system manufacturer for compatibility with the flooring. The specified parameters for installation on such systems must be complied with. Installation on heating systems with a night storage function is out of the question.

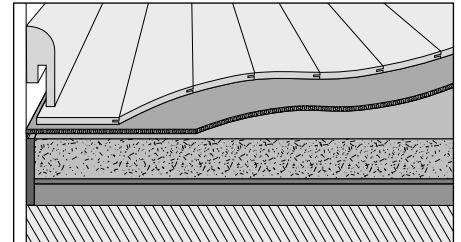

Engineered wood flooring on underlay Akustik-Protect 100 / mineral screed

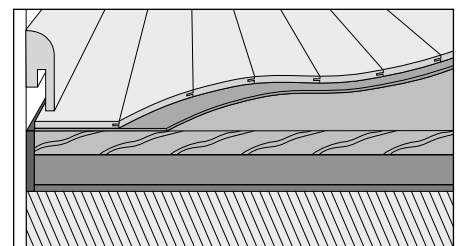

Engineered wood flooring on underlay Akustik-Protect 80 / floorboards

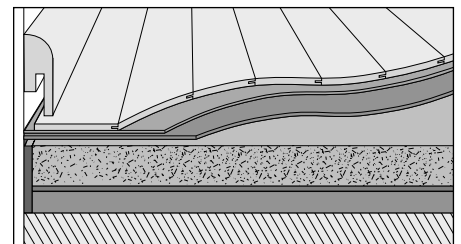

Engineered wood flooring on underlay Akustik-Protect / PVC / mineral screed

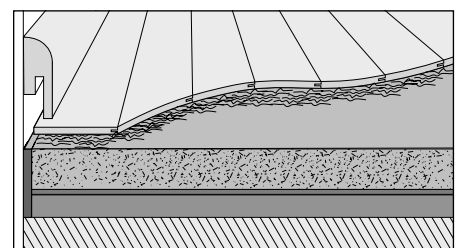

Completely glued engineered wood flooring

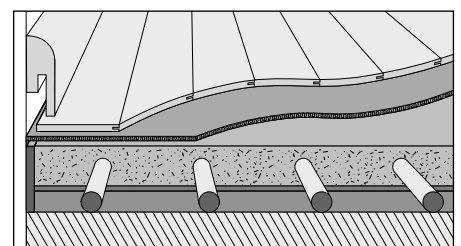

Engineered wood flooring on underlay Akustik-Protect with hot water underfloor heating system

Assembly

Engineered wood flooring Basic 11-5; engineered wood flooring Classic 3025, 3060; engineered wood flooring Trendtime 3, 4, 6, 8 and engineered wood flooring Edition Floor Fields with Automatic-Click® system

Preparation

Once you have taken note of the installation rules and the underlay is installed, it is possible to start with the actual installation of the engineered wood flooring. In order to achieve an even appearance of the first and last row, measure the width of the room at right angles to the direction of installation and work out the width of the planks. Install elements mixed from several packs so that you get an even decorative appearance across the area. The last element of each row is cut to length and the remaining piece, which should not be shorter than 15 cm, is used to start the next row. The cross joints should be offset from row to row by at least 40 cm ("random pattern"). Please check each plank for defects before installation and only lay planks that are in perfect condition.

Note on Trendtime 8 Beech: Please note the following features and special characteristics.

As a prerequisite for the longevity of your flooring, please note the following points:

- › Maintain a comfortable climate of 40-65% (use humidifiers, especially in the winter months, with existing fireplaces and floor-to-ceiling windows with sunlight and conservatories).
- › Parador engineered wood flooring Trendtime 8 Beech must be glued over the whole area. (Please observe the specifications of the respective adhesive manufacturer).
- › Natural characteristics of 3-layer engineered wood flooring beech include the formation of gaps and varying degrees of concave or convex cupping.
- › Store the packages in closed rooms with a climate suitable for the product. Please lay the products from opened packages immediately. Seal packages that have been opened airtight.

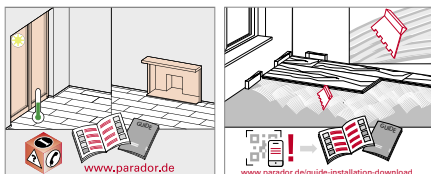

Note on Trendtime 8 Oak Multiplank:

In the case of Trendtime 8 Oak Multiplank, the planks are already mixed at the factory and should be installed carton by carton/always from one carton only. During installation, care should be taken to maintain the mix of differently designed planks. See also page 14 (installation rules).

Assembly

Figure 1: First remove the tongue on the complete first row of planks using a saw, unless you must cut the first row more narrow. Start the first row in the left-hand corner of the room and place the cut side towards the wall. The required wall clearance of 10–15 mm is achieved with the Parador plastic spacer wedges. If the wall is not straight and lock the head joints together, see p. 19, Figure 7.

Figure 2 and 3: Start from the left with the first plank of the second row and click it into the long side of the first row. To do this, guide the tongue side of the plank into the groove of the previous row at an angle of approx. 25° and then lower the plank. The plank clicks in when lowered, resulting in a tight fit with no play.

Figure 4: The following plank, like all the rest, is then clicked in place in the same way on the long side and pushed tight to the head end of the previous plank. The solid top layers must abut!

Note: Parador recommends that products in the Trendtime 9 range should be installed using the all-over gluing method in addition to gluing the end head-joints – this recommendation will significantly reduce climatic changes of the tension in the product.

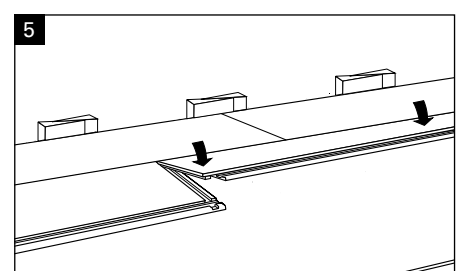
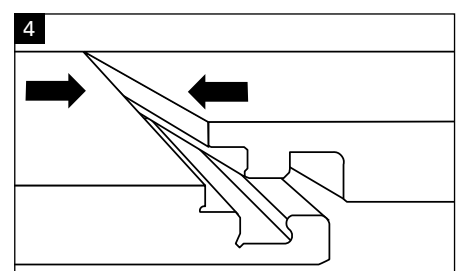
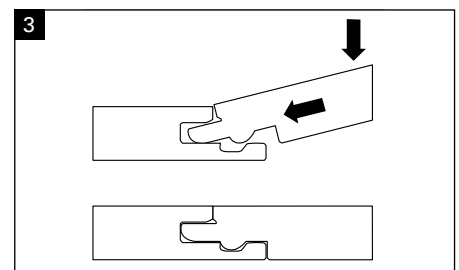
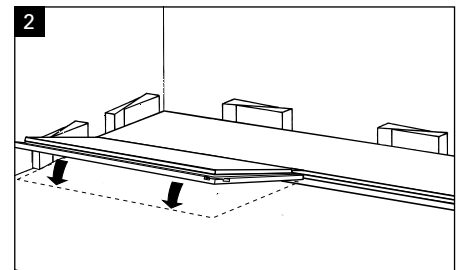
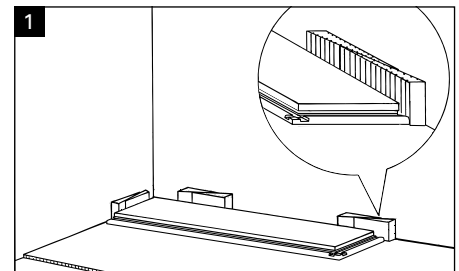

Assembly

Basic 11-5; Classic 3025, 3060; Trendtime 3, 4, 6, 8 and engineered wood flooring Edition Floor Fields with Automatic-Click® system

Figure 5 (p. 16), 6 and 7: The longitudinal joint along the complete plank must be locked from the left to the right by simply pressing it in place and pushing it down. Before locking the head joint it is important that the complete longitudinal joint is closed. Then lock the head joint by joining the planks using a hammer and protective block. Be sure that the head ends are tightly together because otherwise it is not possible to lock them. Install all other planks accordingly.

Figure 8: For disassembly, lift the complete row of planks up and pull it from the previous row at an angle. Then lever the head joints apart starting at the last installed plank section. The locking mechanism remains intact and the planks can be reused.

Please note: Avoid tilting the planks as this may damage the locking mechanism.

Figure 9: Measuring the end piece using a square (place plank with groove side next to the previous row) and saw off. Remember the wall clearance! When using a jigsaw, place the top side of the plank facing down. When using a table saw, place the top side of the plank facing up.

Figure 10: Measuring the last row using a plank remnant. Remember 10–15 mm wall clearance.

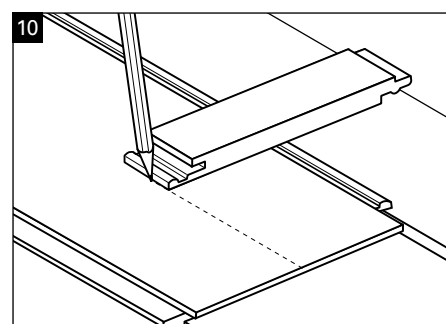
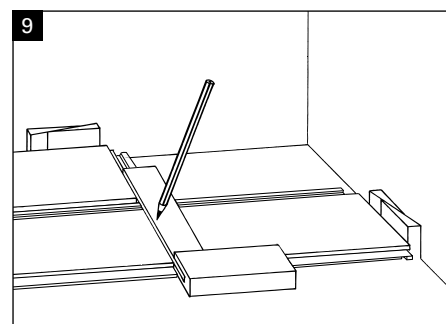
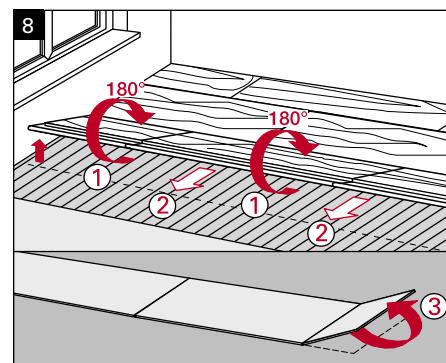
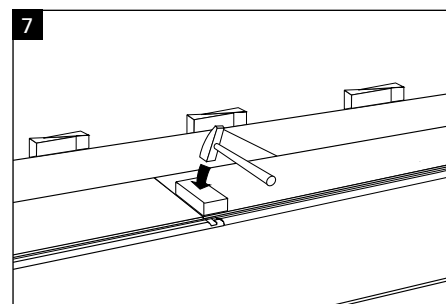
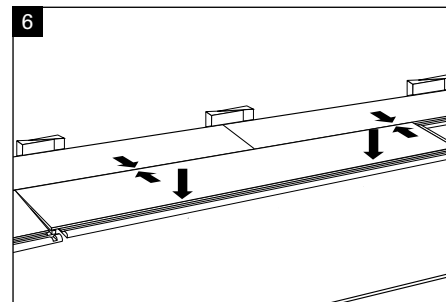

Assembly

Basic 11-5; Classic 3025, 3060; Trendtime 3, 4, 6, 8 and engineered wood flooring Edition Floor Fields with Automatic-Click® system

Figure 11: Following removal of the plastic spacer wedges and attachment of skirting boards with either clip technology or adhesive, in the case of a floating installation, the floor is ready to walk on. In the case of a whole-area gluing, the adhesive must be allowed to dry (approx. 24 hours) before the floor can be walked on (please refer to recommended drying times on the adhesive label).

Figure 12: Wall not straight: Align the first row straight, then follow the wall shape. Draw the relevant width on the plank (as shown in the image) and then cut the plank along that mark.

Figure 13: Shortening a door frame: place a plank remnant (on the relevant underlay) against the frame and cut the frame along the plank.

Figure 14: Pipe opening: Make the diameter of the pipe holes 20 mm larger than the pipe is. Mark the holes, drill out and saw off at an angle of 45° as shown. Glue the sawn out piece in place. Do not forget wall clearance.

Figure 15: Installation in hard to access areas: If you cannot insert the planks at an angle and lock them, then we recommend removing the snap-in tongues on the bottom of the tongue and to glue the planks. Place glue on the bottom edge of the groove and push the planks into each other (common tongue and groove principle).

Figure 16 and 17: Glue information: If underlay requirements for regionally specific standards are outside of the tolerance range for the specific engineered wood flooring with regard to levelness (3 mm/1 m) or relative humidity (30–65%), we recommend gluing (see Figure 16).

The same applies to the head side (Figure 17) if using on an underfloor heating system.

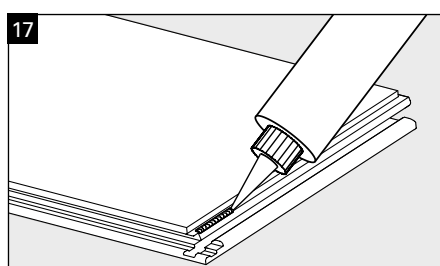
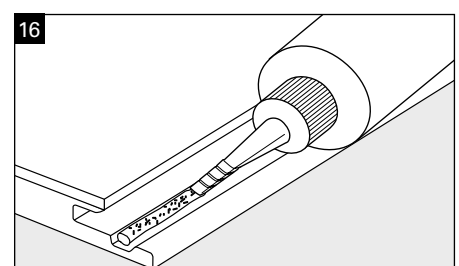
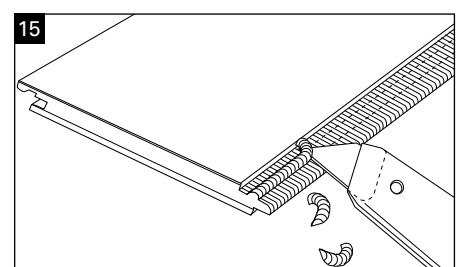
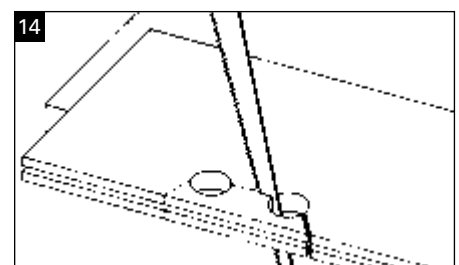
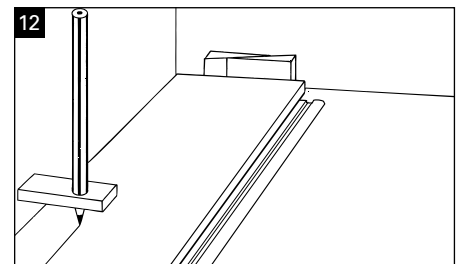
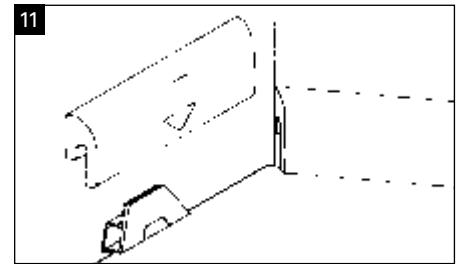

Assembly

Engineered wood flooring with Allround-Click® system: Trendtime 3 (herringbone) for glue-down installation

Figure 1: Although it is possible to install Trendtime 3 (herringbone) using the 'floating' method, some settling noises may be apparent such as when using close to wet areas or in the case of special stresses and strains. Parador therefore recommends Trendtime 3 (herringbone) to be fully glued over the sub-floor (concrete, screed etc.).

Please also refer to page 33 Chapter: Checklist for all-over gluing of Parador engineered wood flooring.

Please also note the glue manufacturer's information.

Preparation

Following familiarization of the installation guidelines and if an underlay is required and has been fitted, installation of the floor-covering can commence.

Figure 2: When installing strips (herringbone), the room impression is highly dependent on the installation type. In the 0° direction, installation is parallel to the room walls.

Figure 3: If herringbone pattern is installed diagonally across the room, this is the so-called "45°" direction.

Figure 4: You require only the "universal" strip developed by Parador to install herringbone patterns. You do not need left and right strip. With this strip, you can recreate the installation patterns shown above, the installation direction is not pre-specified. You can start in a corner of the room (then preferably by rows (Figure 4a) or centred in the room (then preferably by strips (Figure 4b)).

Figure 5: With the recommended installation direction it must be noted that the strips must be installed so that the groove side of the strips is in the direction of installation and that the tongue is clicked into the groove. If the groove is clicked into the tongue, especially in the case of all-over gluing, the strip or set of strips may lift.

Notes: Please note the handling instructions and the use and hardening times for engineered wood flooring glue.

Please combine strips from different packs (Figure 2 and 3). This will reduce the chances of similar looking strips being installed next to each other and is more likely to achieve a more balanced overall appearance of the flooring.

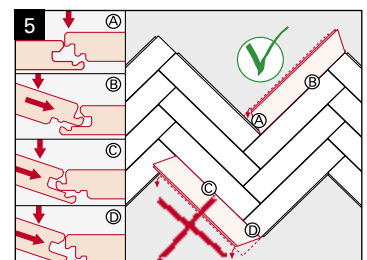
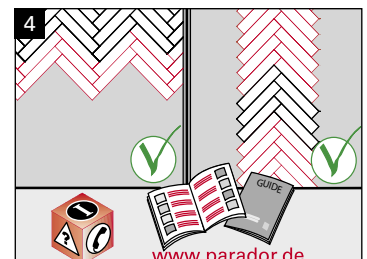
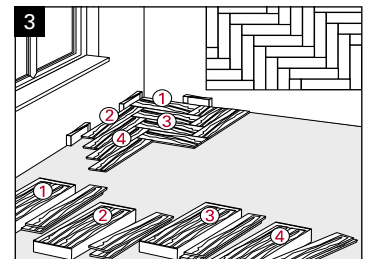
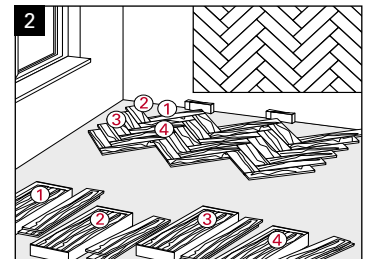
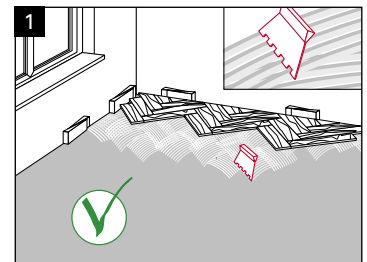

Assembly

Engineered wood flooring with Allround-Click® system: Trendtime 3 (herring-bone) for glue-down installation

Installation principle

Figure 6: Please check each strip for defects before installation and only lay strips that are in perfect condition.

Figure 7: Find the centre of the opposite wall to determine the main orientation. After shifting this spot parallel by 3.5 cm, the axis is directly above the tips of the strip (as shown). This axis can be marked with a line, if necessary. Adjust the edge strips. Saw cut under 45° or pursuant to the wall contour. Please remember the wall clearance of 8–10 mm. This wall clearance all around must also be maintained to built-in objects.

Figure 8: A custom-cut strip must be inserted into triangular free areas. This piece should be held in position by a weight over its' edge areas to avoid any protrusions, until the glue has hardened.

Figure 9: Remove the plastic spacer wedges and attach the skirting board using either the patented clip technology or Parador construction adhesive. The floor is ready to walk on as soon as the glue has hardened (approx. 24 hours).

Figure 10: Shortening a door frame: place a plank remnant against the frame and cut the frame along the plank. To do this, place the plank remnant on an approx. 2 mm high underlay to imitate the height of the adhesive.

Figure 11: In areas where the strips cannot be swivelled into place (door frames, radiator pipes, etc.), they must be inserted horizontally. For this, the snap-in tongues must be removed using a knife.

Note: If Trendtime 3 is to be installed using the floating method, it is strongly recommended that all four sides of the strip should be glued.

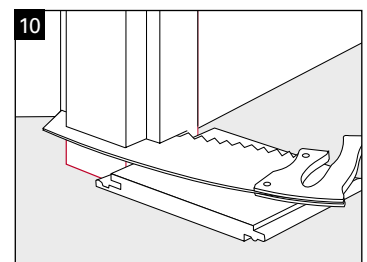
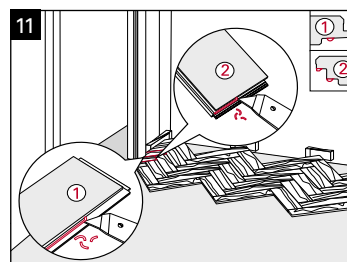
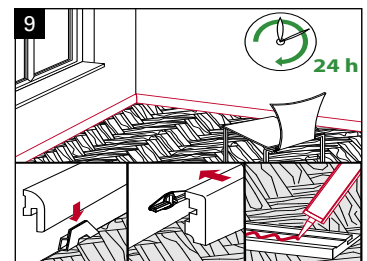
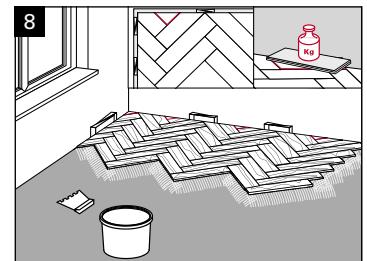
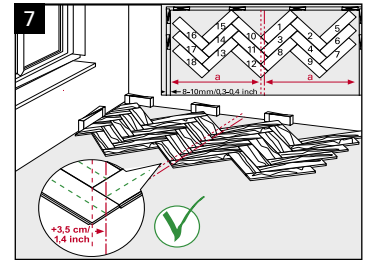
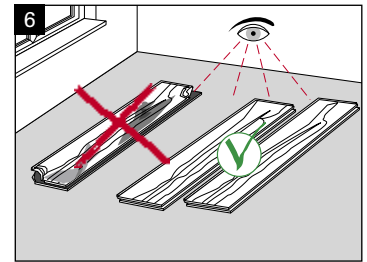

Assembly

Engineered wood flooring Edition New Classics with tongue and groove connection

Preparation

Following familiarization of the installation guidelines and once any underlay has been fitted, installation of the floor-covering can commence.

Figure 1: Engineered wood flooring Edition New Classics consists of two different modules to achieve the chevron look. Only one type of module is used within one row to be installed.

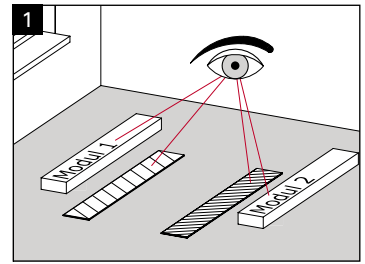

Installation principle

Figure 2: The planks are whole-area glued on screed. Install by offsetting the end joints by one half plank length in each row. This creates a calmer and more coordinated installation pattern. A random pattern installation as shown in the bottom half of the figure is also possible. The cross joints should be offset by at least 40 cm.

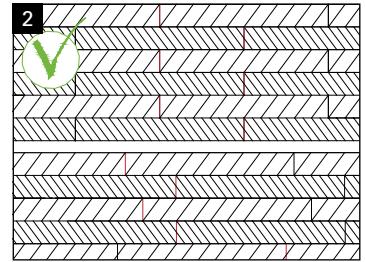

Please check each plank for defects before installation and only lay planks that are in perfect condition.

Installation pattern

Figure 3: Different installation patterns and room effects are possible. We would like to show you three options:

- Option 1: common installation, 1 module type per row
- Option 2: double braid, 2 rows each with one module type
- Option 3: diagonal installation pattern, use only one module type throughout the complete room

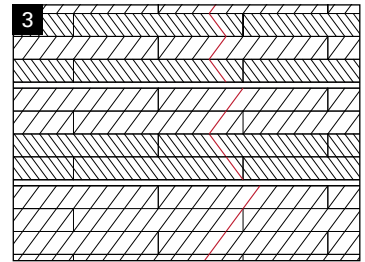

Figure 4: For a mixed look, it is important to pay attention to the crossbar offset when inserting a new row. The crossbar offsets can be optimized by shifting to the side. Please note that minor offsetting is permissible here and is not avoidable.

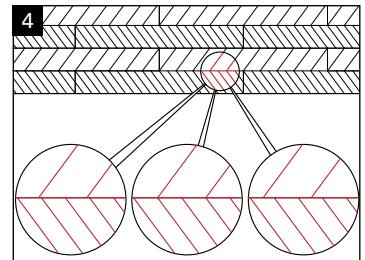
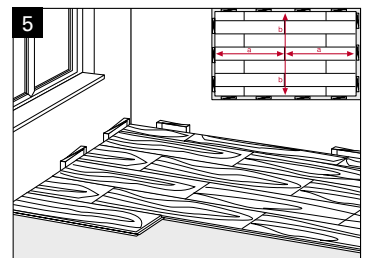

Figure 5: To achieve an even appearance of the first and last row, measure the width of the room at right angles to the direction of installation and calculate the width of the planks.



Assembly

Engineered wood flooring Edition New Classics with tongue and groove connection

Figure 6: First remove the tongue on the complete first row of planks using a saw, unless you need to cut the first row narrower. Start in the left-hand corner of the room. The required wall clearance of 10–15 mm is achieved with the Parador plastic spacer wedges.

Figure 7: The last element of each row is cut to length and the remaining piece, which should not be shorter than 15 cm, is used to start the next row.

Figure 8: The cross joints should be offset from row to row by at least 40 cm ("random bond").

Figure 9: Use the hammering block and hammer to fit the planks together and push the plank into the previous plank until the joint has closed.

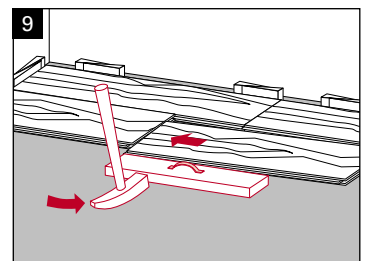
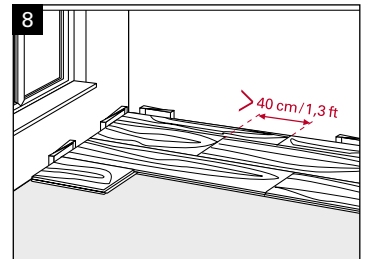
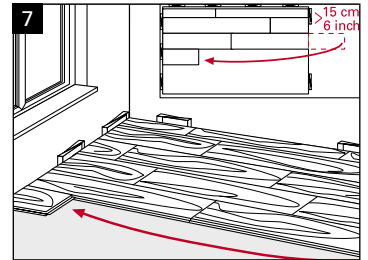
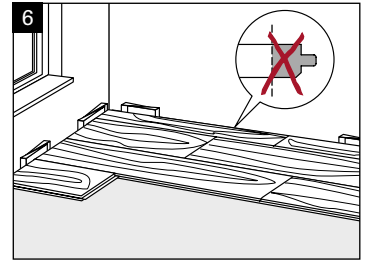

Assembly

Engineered wood flooring Edition Open Frameworks with loose and fixed tongue connection for glue-down installation

Preparation

Following familiarization of the installation guidelines and once any underlay has been fitted, installation of the floor-covering can commence.

Open Frameworks consists of four different modules (planks) and four different links.

Figure 1: This flooring is designed for whole-area gluing to the subfloor.

Tongues (free tongues and tongues on the planks) must not be glued inside the grooves.

Ensure that you have sufficient free tongues available (narrow planks and links one tongue each and wide planks and links two tongues each).

Installation principle

The planks are whole-area glued on screed. The Parador tongue is responsible for the top flush connection to connect the individual planks and links (adhesive has dried completely after 24 hours). The tongues are inserted into an end side plank/link groove or, depending on the desired installation pattern, possibly also into the long side plank/link groove. Right and left planks/links are therefore not required.

Figure 2: Please check each plank for defects before installation and only lay planks and links that are in perfect condition.

Whole-area glued planks/links require the continuous review that all joints are closed. A possible displacement, for example, by using the hammering block or Parador MultiTool, before the hardening time of the Parador glue is reached must be noted or the above review must be performed and open joints must be closed.

Installation pattern

Figure 3 to 7: Different installation options are possible with the free and fixed tongue connection. A few herringbone style options are shown as examples

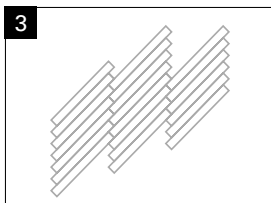
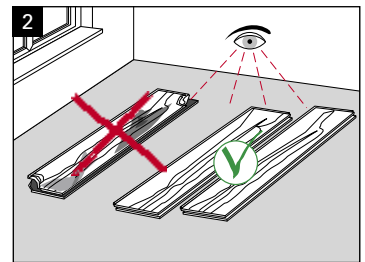
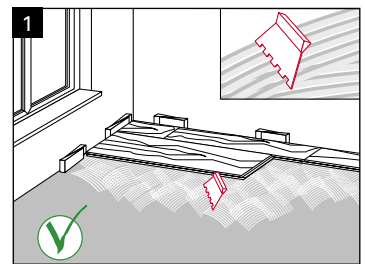

3 Herringbone

Single

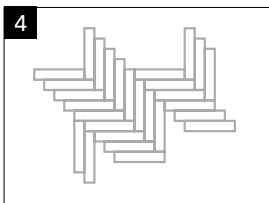

4 Straightforward

installation

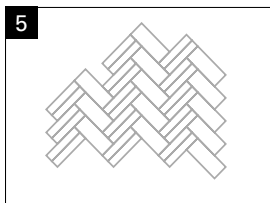

5 Format mix

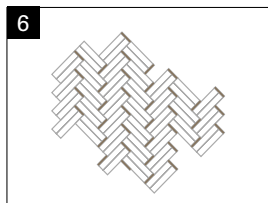

6 Links

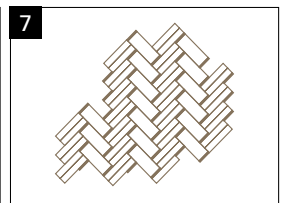

7 Format mix with links

A great variety of other installation options (e.g.: basic, ladder, block, etc.) is possible with engineered wood flooring Edition Open Frameworks.

Assembly

Engineered wood flooring Edition Open Frameworks with loose and fixed tongue connection for glue-down installation

Assembly

The installation of Edition Open Frameworks in the standard lengthways installation is shown as an example.

Figure 8: Please consider the room situation to receive an even installation, centre the area accordingly, if necessary.

Figure 9: First remove the tongue on the complete first row of planks using a saw, unless you need to cut the first row narrower. Start in the left-hand corner of the room. The required wall clearance is at least 10 to 15 mm and is achieved using the Parador plastic spacer wedges.

Figure 10: Fit the tongues into the end groove (in case of narrow planks or small links, 1 tongue and in case of wide planks or large links 2 tongues).

Figure 11: The cross joints should be offset from row to row by at least 15 cm (for standard lengthwise installation).

Figure 12: Saw off the respective last element of a row and the remainder, which must not be shorter than 15 cm is used to start the next row. The last element is inserted with a drawbar and a hammer. In case of cross joints, they should be offset by at least 15 cm.

Note: As a general rule, install the corresponding tongue for each plank and link.

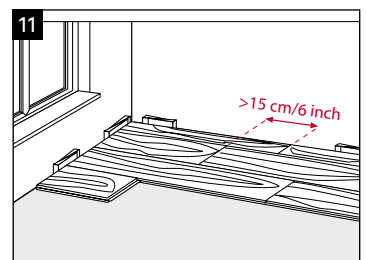
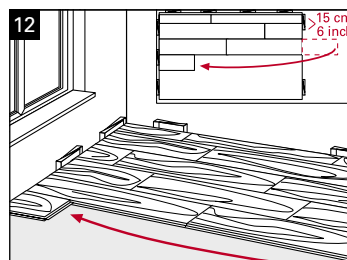
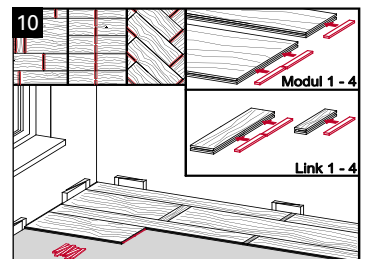
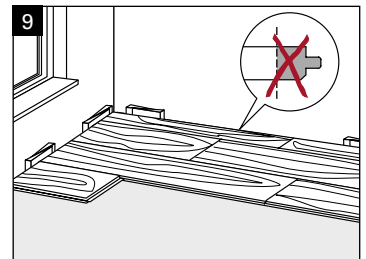
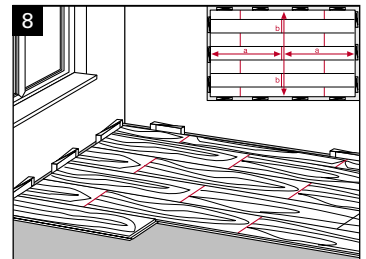

Assembly

Engineered wood flooring Edition Open Frameworks with loose and fixed tongue connection for glue-down installation

Figure 13, 14, and 15: Use the hammering block or the Parador MultiTool and a hammer to fit the planks together on the long and end edge and push the plank into the previous plank until the joint has closed.

Remove the spacer wedges and attach the Parador skirting board using the patented clip technology or Parador construction adhesive. The floor is ready to walk on as soon as it has been installed and the glue has hardened (approx. 24 hours).

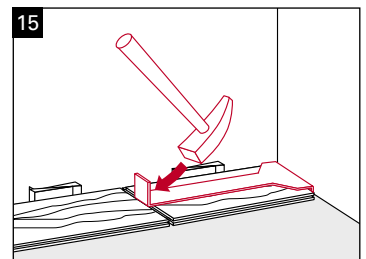
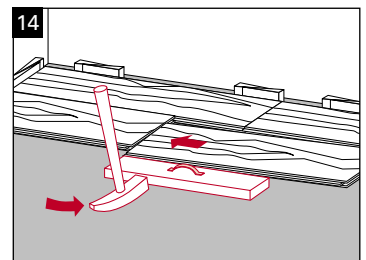
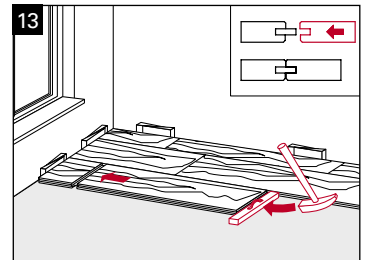

Retain value, cleaning, and care

Parador engineered wood flooring is easy to clean and care for thanks to finished surfaces. So that you enjoy your floor for years to come, here is some information about value retention, cleaning and care:

Retain value

General information on retaining the value of your engineered wood flooring:

- › 30-65% (exception: 40-65% for the wood type beech) relative humidity is optimal for Parador engineered wood flooring and also recommended for people's well-being.
- › Avoid sand and dirt as both act like sandpaper.
- › Immediately wipe up liquids lodging on the floor.
- › Only wipe with a slightly damp cloth
- › Do not use any abrasives, floor wax, or polishes. Among other things, they tarnish the floor's appearance
- › Fit chairs and tables with soft felt pads. Office chairs should have soft rollers, otherwise use suitable floor mats in these heavily used areas
- › Do not use steam cleaners.
- › Please use cleaning and routine care products from the Parador product range

Avoid damages

As with all other floor coverings, you should protect your new engineered wood flooring from dirt particles by using suitable dirt-trapping zones (mats) (Figure 1). To protect the engineered wood flooring from scratches, suitable soft felt pads must always be fitted under chair and table legs and under pieces of furniture (Figure 2). Rollers on office chairs, file trolleys and roller containers should be fitted with soft treads/rollers (type W pursuant to EN 12529) (Figure 3). There is also the option of protecting the floor in these heavily used areas with suitable mats (available in office supply stores). It is not necessary to wax lacquered engineered wood flooring or give it an additional seal, as such measures can in no way improve the floor's looks or benefits of use. **We recommend that you clean your engineered wood flooring regularly with a vacuum cleaner (attached bristles) or broom. Cleaning with a slightly damp cloth should only be done in case of stubborn dirt. It is important in this case that the cloth is well wrung out and that no puddles form with standing water.**

Final construction cleaning

- › Remove drilling dust and loose particles with a broom or vacuum cleaner with attached bristles.
- › If necessary, wipe the floor with a damp cloth using standard detergents.
- › Ensure that the floor is wiped only damp, never wet.

Routine cleaning

- › Remove dust, fluff, and loose particles with a broom or vacuum cleaner with attached bristles.
- › Dirty marks are wiped off with a damp cloth.
- › For routine cleaning and value retention we recommend the Parador care set with special cleaning and care products.
- › In case of stubborn dirt, wipe the floor with a damp cloth using Parador cleaning products.
Use only cleaning and care products from the Parador product range suitable for the respective surface of the engineered wood flooring.

Repairing more serious scratches and damages

- › The damaged areas can be repaired with the colour-coordinated Parador Premium repair set.
- › Use the Parador varnish retouching pen to touch up light scratches.

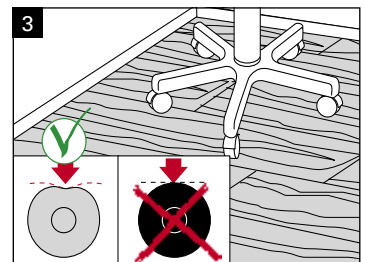
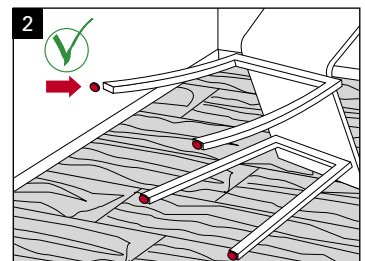
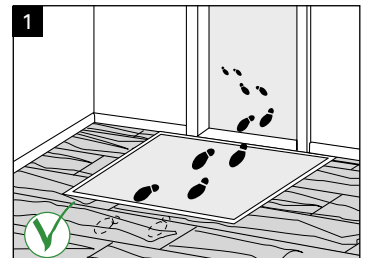

Retain value, cleaning, and care

Maintaining lacquered finishes and naturally oiled / natural oiled plus surfaces / oil impregnated surfaces (UV oil) / Professional ("contract lacquer")

Note: The specified care rules also apply to engineered wood flooring with the surface finish extra matt lacquer professional. The care must not deviate from the specifications for the usual lacquered finishes.

Although various oil, oil/wax, or wax systems are available on the market (and a list of approved suppliers is listed below), we recommend the use of maintenance products from the Parador range to maintain all Parador engineered wood flooring surfaces. You should choose one system. If a system is used in combination with water or soaps, please be sure that the flooring is always wiped damp, not wet, and that the cloth is always well wrung out. Avoid puddles and standing water.

Parador naturally oiled, natural oiled plus, and oil impregnated (UV oil) surfaces can be treated with all commercially available cleaning and care products for air-drying or oxidatively drying natural oil surfaces and oil-impregnated (UV oil) surfaces.

In the case of the ready to use finish, depending on the use/load and to retain the floor's value over the long term, an initial care treatment is not necessary (excepting the natural oil surface used on products in the Basic 11-5 range). Maximum oil absorption of engineered wood flooring surfaces is achieved in the plant (see exceptions below, engineered wood flooring Basic 11-5).

Ongoing maintenance of the flooring at periodic intervals will be required depending on the amount of wear.

Please refer to the suppliers' cleaning and maintenance instructions.

Complete renovation through sanding

If the engineered wood flooring will be renovated due to damages or other impairments, in case of lacquered and oil-impregnated (UV oil) engineered wood flooring, the complete surface must be sanded. In case of naturally oiled and naturally oiled plus flooring, it can also be sanded only partially. Approx. 0.5 mm are sanded off per sanding process. Engineered wood flooring can therefore be sanded multiple times. You can use corresponding lacquer or oil products from specialty trade for the subsequently required surface treatment. Various surface products are offered as lacquer, oil, or wax sealants. You can use all systems recommended for engineered wood flooring by the respective manufacturer. A completely sanded off floor can also be treated with Parador Pro care oil for real wood flooring from the Parador product range.

Maintenance of brushed/textured surfaces

Brushed or textured surfaces require more care and are more sensitive to dirt. Please pay particular attention to larger dirt-trapping areas. Textured flooring should be cleaned in the direction of the texture.

* For products from the product range Basic 11-5 engineered wood flooring, Parador recommends initial care for long-term maintenance of the original look (please use the profile care oils from the Parador product range).

Template acceptance protocol for professional installers

Mr. / Mrs.: _____ Order number: _____

Street: _____ Protocol number: _____

Postal code /Town: _____ Date: _____

Installed on: _____

Pos.	Quantity (target)	Quantity (actual)	Article
1	_____ m ²	_____ m ²	Removing existing floor coverings/m ² Basis
2	_____ m ²	_____ m ²	Flooring installation
3	_____ m	_____ m	Profile insertion
4	_____ m	_____ m	Attaching skirting boards
5	_____ Pcs.	_____ Pcs.	Shorten doors
6	_____ Pcs.	_____ Pcs.	Shorten door frames
7	_____ Pcs.	_____ Pcs.	Swapping planks

Particularities/remarks: _____

The installed floor was evaluated from a standing position, without angular light or other light refraction (e.g. backlight) and without deviations from situations of use. The floor has no damages or defects. The cleaning and care instructions for the installed floor were handed over to the user/client.

Signature end user and/or orderer

Date, place

Checklist for installation on hot water underfloor heating

As a matter of principle, all mineral subfloors must be heated before installing engineered wood flooring so that damaging moisture can no longer escape. This heating process applies to all times of the year, winter or summer. The screed must be professionally laid according to the generally acknowledged rules of the trade (DIN). It must dry out for at least 21 days before the heating process can begin. We recommend heating the screed according to the following diagram or using the "heating protocol" template. Please observe additional information given by your screed layer and heating engineer.

Note: Also see section Installation options: Installation on underfloor heating

Heating diagram for a hot water underfloor heating system

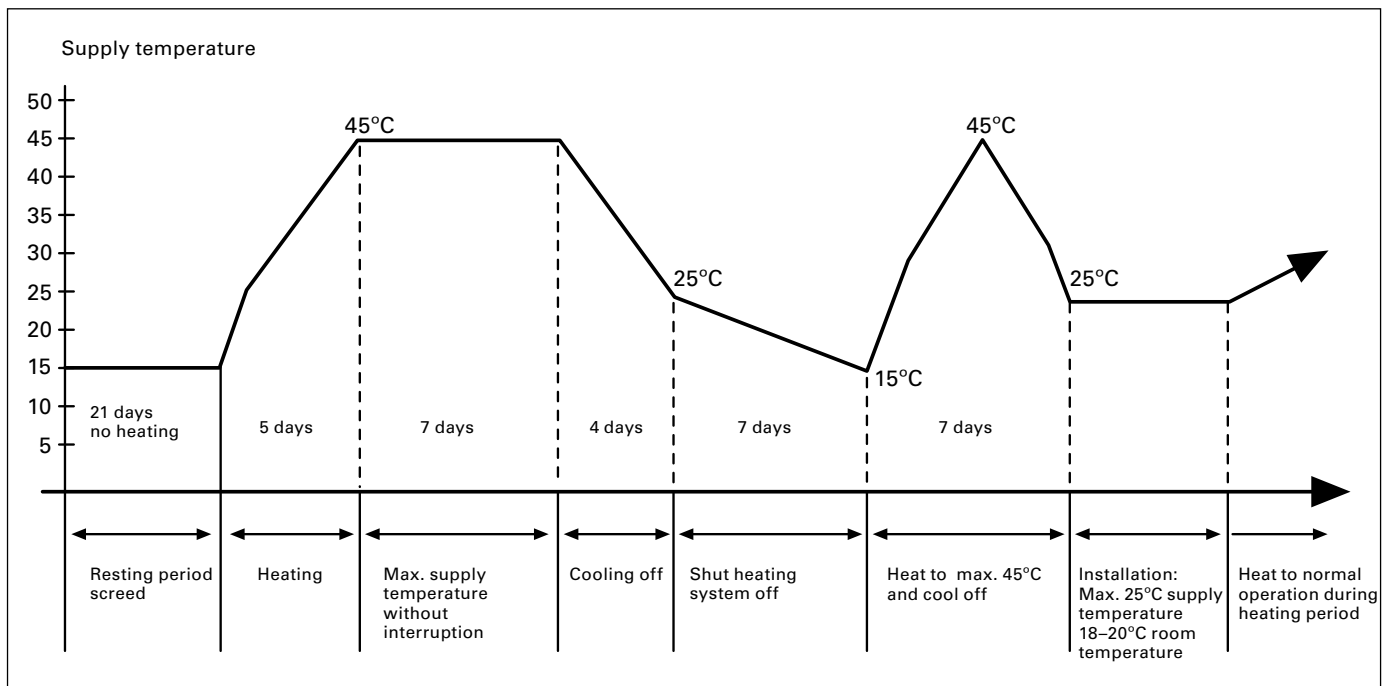

Please bear in mind: The surface temperature of the engineered wood flooring should ideally not exceed 25°C (max. 29°C).

Heating protocol for hot water underfloor heating systems (template)

It is essential to keep a heating protocol for newly installed hot water underfloor heating systems.

1. a) The screed work was finished on _____ .
 - b) It is a cement anhydrite screed.
 - c) The thickness of the screed is _____ cm.
2. a) The heated flooring construction was taken into operation on _____
_____ and heated up to 45°C with a daily temperature increase of 5°C (supply temperature).
 - b) This maximum temperature was maintained for _____ (target: 7 days) without lowering the temperature at night.
 - c) From _____ to _____ (target: 4 days), the supply temperature was reduced by 5°C a day.
 - d) From _____ to _____ (target: 7 days), the heater was shut off.
 - e) The heater was started again on _____ and on
_____ the supply temperature of 45°C was reached.
 - f) After reaching the supply temperature of 45°C, the supply temperature was reduced in stages of max. 10°C a day
(max. 25°C) until the room temperature reached approx. 18-20°C for the installation of laminate and engineered wood flooring.
3. During the heating and cooling off period, were the areas ventilated but draughts prevented? yes
4. The last moisture measurements at the measuring points marked showed _____ % residual moisture.
(Permitted values: anhydrite screed max. 0.3 CM %, cement screed max. 1.5 CM %)
5. The heated floor surface is hereby approved for the installation of wear layers/floor coverings.

For the builder/client:

Place/date/signature/stamp

The notes are used to advise the installer/heating engineer and the builder. Warranty claims cannot be derived from this. In case of doubt, corresponding regulations stipulated by the screed layer/heating engineer must be followed.

Checklist for gluing the whole area of Parador engineered wood flooring

Parador engineered wood flooring can alternatively also be installed by whole-area gluing. The products Trendtime 3, Edition New Classics with tongue and groove connection and Open Frameworks with loose and fixed tongue and groove connection are designed for whole-area gluing and not suitable for floating installation. Whole-area gluing offers several advantages over floating installation. Please note the following:

- › As a surface area adhesive, only water and solvent-free, one or bi-component (1-C or 2-C) polyurethane adhesives recommended for this purpose by the adhesive manufacturer, or solvent-based adhesives in accordance with DIN 281, should be used. The adhesive manufacturer's specifications, particularly with regard to applying the adhesive (e.g. use of the correct adhesive application trowel) must be observed.
- › Parador recommends T54 FC and 151 Objekt adhesives by Sika. These adhesives are suitable for all commonly available types of wood, e.g. beech or oak. Please contact the adhesive manufacturer in case of question and observe the corresponding data sheet.
- › The subfloor must be dry, level, free from cracks, clean, and suitable for gluing. The relevant moisture levels must not be exceeded. Pretreatment depends on the manufacturer's information.
- › Screeds must not exceed the following moisture level:

	Anhydrite screed	Cement screed
without underfloor heating system	max. 0.5 CM %	max. 2.0 CM %
with underfloor heating system	max. 0.3 CM %	max. 1.8 CM %
- › An appropriate clearance of at least 10 mm must be maintained to all fixed objects (see Installation rule 6 and 7).
- › Movement joints located in the subfloor must be transferred. Movement joints are also recommended in all doorways, room passages, and once every 15 m (in lengthwise and crosswise direction).
- › The general notes from the assembly instructions should also be observed when gluing the whole area.
- › You can find further information on the adhesive manufacturer's website (e.g. www.sika.de) or contact the Parador application technology department in case of doubt.

parador.de/en

Vinyl flooring | Modular ONE
Engineered wood flooring
Laminate flooring
ClickBoard | Panels
Mouldings and accessories

Parador GmbH
Millenkamp 7-8
48653 Coesfeld
Germany

Hotline +49 (0)2541 736 678
info@parador.de
www.parador.de
www.facebook.com/parador

Status: 5/2021 © Parador
Subject to errors and alterations